

# Product Catalogue

Infection Prevention

# TABLE OF CONTENTS

**Surgical Drapes & Packs**  
1 - 18

**Surgical Gowns**  
19 - 24

**Protective Apparels**  
25 - 32

**Surgical & Examination Gloves**  
33 - 36

**Minor Procedure Sets/Trays**  
37 - 48

**SURGICAL Solutions**



NONWOVEN CONVERTING

# Surgical Drapes and Packs

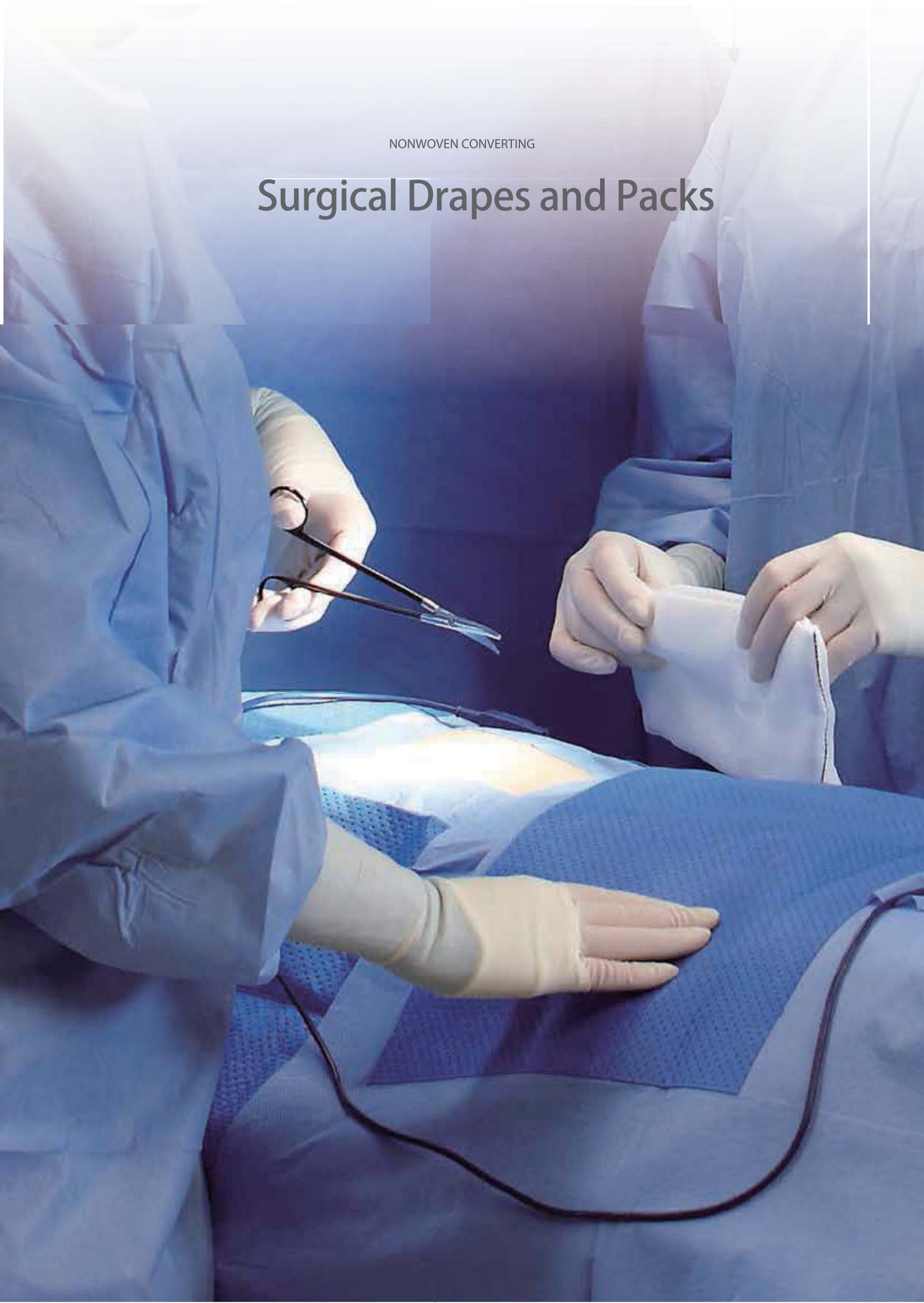

# Surgical Drapes and Packs

## General Surgery Packs

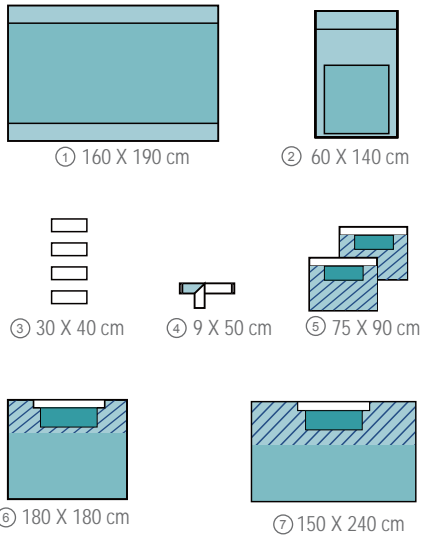

### Universal Pack with Mayo Stand Cover

REF 1011

No.	Product Name	Size	Quantity
1	Back Table Cover	160×190cm	1
2	Mayo Stand Cover	60×140cm	1
3	Towel	30×40cm	4
4	Op-Tape	9×50cm	1
5	Adhesive Side Drape	75×90cm	2
6	Adhesive Bottom Drape	180×180cm	1
7	Adhesive Top Drape	150×240cm	1

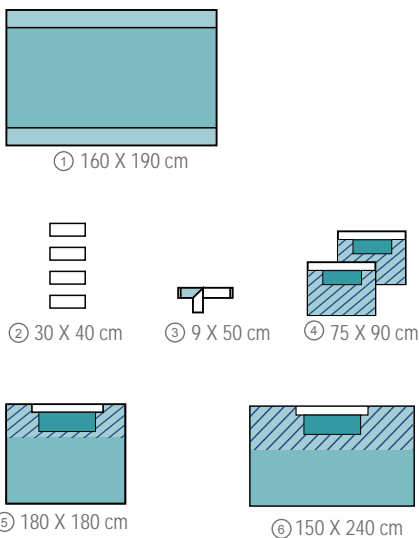

### Universal Pack without Mayo Stand Cover

REF 1012

No.	Product Name	Size	Quantity
1	Back Table Cover	160×190cm	1
2	Towel	30×40cm	4
3	Op-Tape	9×50cm	1
4	Adhesive Side Drape	75×90cm	2
5	Adhesive Bottom Drape	180×180cm	1
6	Adhesive Top Drape	150×240cm	1

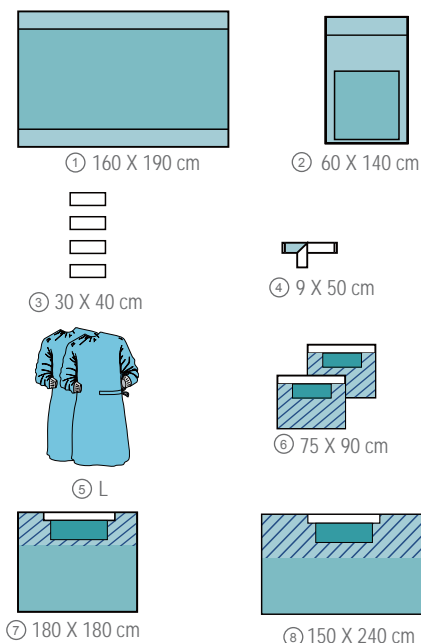

### Universal Pack with Mayo Stand Cover & Gown

REF 1013

No.	Product Name	Size	Quantity
1	Back Table Cover	160×190cm	1
2	Mayo Stand Cover	60×140cm	1
3	Towel	30×40cm	4
4	Op-Tape	9×50cm	1
5	Standard Gown	L	2
6	Adhesive Side Drape	75×90cm	2
7	Adhesive Bottom Drape	180×180cm	1
8	Adhesive Top Drape	150×240cm	1

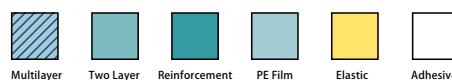

# Surgical Drapes and Packs

## General Surgery Packs

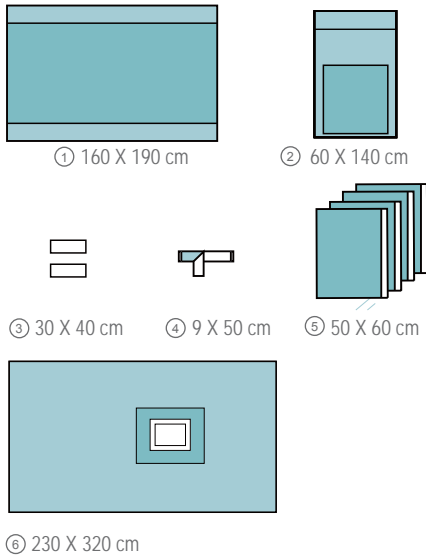

### Laparotomy Pack

REF 1014

No.	Product Name	Size	Quantity
1	Back Table Cover	160×190cm	1
2	Mayo Stand Cover	60×140cm	1
3	Towel	30×40cm	2
4	Op-Tape	9×50cm	1
5	Adhesive Utility Drape	50×60 cm	4
6	Laparotomy Drape	230×320cm	1

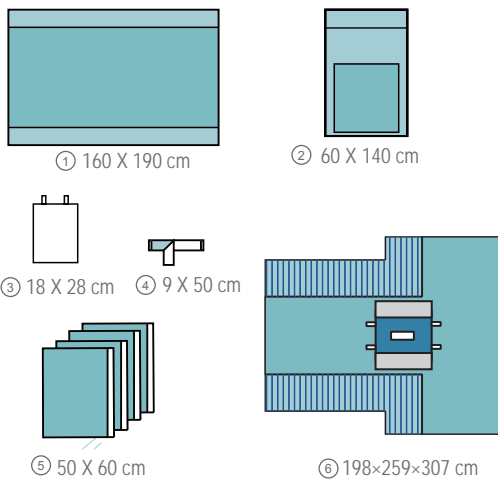

### Laparoscopy Pack I

REF 1015

No.	Product Name	Size	Quantity
1	Back Table Cover	160×190cm	1
2	Mayo Stand Cover	60×140cm	1
3	Suture Bag	18×28cm	1
4	Op-Tape	9×50cm	1
5	Adhesive Utility Drape	50×60 cm	4
6	Laparoscopy Drape with Hook-loop Line Holders	198×259×307 cm	1

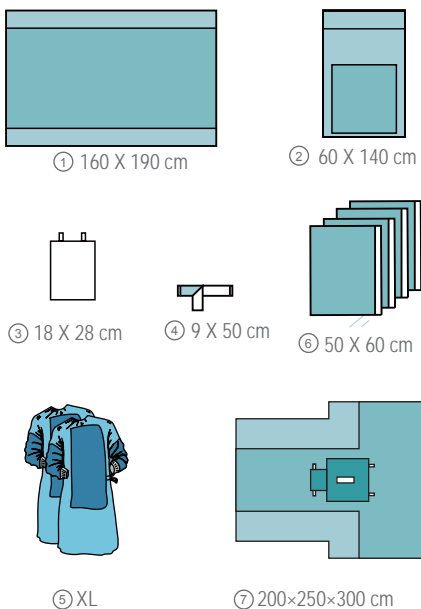

### Laparoscopy Pack II

REF 1016

No.	Product Name	Size	Quantity
1	Back Table Cover	160×190cm	1
2	Mayo Stand Cover	60×140cm	1
3	Suture Bag	18×28cm	1
4	Op-Tape	9×50cm	1
5	Reinforced Gown	XL	2
6	Adhesive Utility Drape	50×60 cm	4
7	Laparoscopy Drape with Hook-loop Line Holders	200×250×300 cm	1

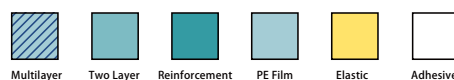

# Urology & Gynecology Packs

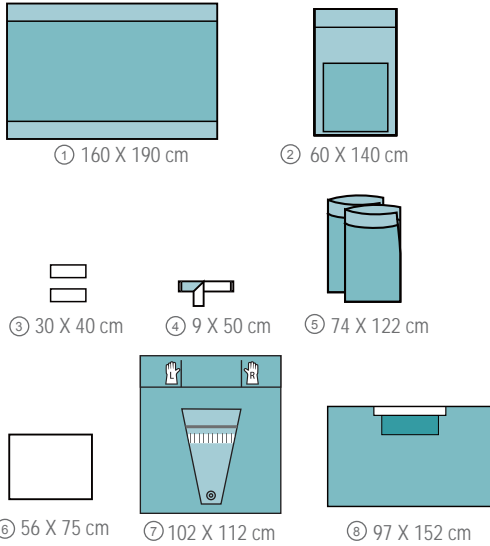

## Obstetrical Pack

REF 1017

No.	Product Name	Size	Quantity
1	Back Table Cover	160×190cm	1
2	Mayo Stand Cover	60×140cm	1
3	Towel	30×40cm	2
4	Op-Tape	9×50cm	1
5	Legging	74×122cm	2
6	Baby Blanket	56×75cm	1
7	Under Buttocks Drape	102×112cm	1
8	Adhesive Abdominal Drape	97×152cm	1

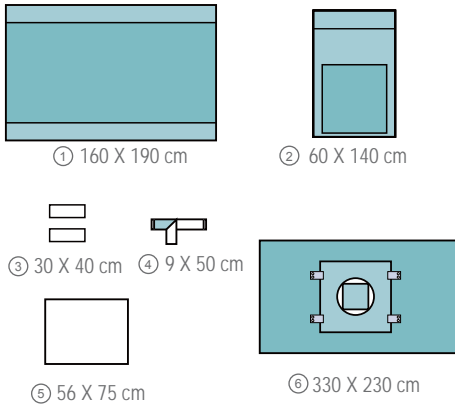

## Cesarean Pack I

REF 1018

No.	Product Name	Size	Quantity
1	Back Table Cover	160×190cm	1
2	Mayo Stand Cover	60×140cm	1
3	Towel	30×40cm	2
4	Op-Tape	9×50cm	1
5	Baby Blanket	56×75cm	1
6	Cesarean Drape I	330×230 cm	1

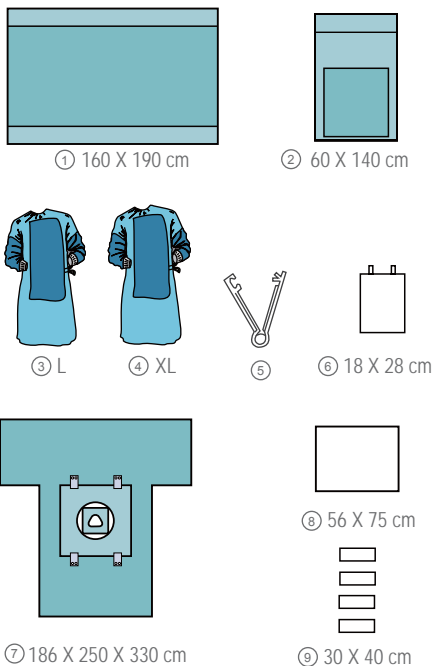

## Cesarean Pack II

REF 1019

No.	Product Name	Size	Quantity
1	Back Table Cover	160×190cm	1
2	Mayo Stand Cover	60×140cm	1
3	Reinforced Gown	L	1
4	Reinforced Gown	XL	1
5	Clamp		1
6	Suture Bag	L	1
7	Cesarean Drape II	186×250×330 cm	1
8	Baby Blanket	56×75cm	1
9	Towel	30×40cm	4

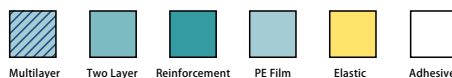

# Surgical Drapes and Packs

## Urology & Gynecology Packs

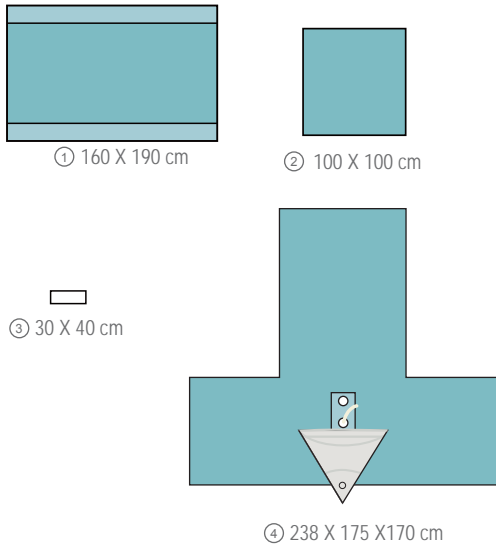

### T.U.R Pack

REF1020

No.	Product Name	Size	Quantity
1	Back Table Cover	160×190cm	1
2	Sterilization Wrap	100×100 cm	1
3	Towel	30×40 cm	1
4	T.U.R Drape	238×175×170cm	1

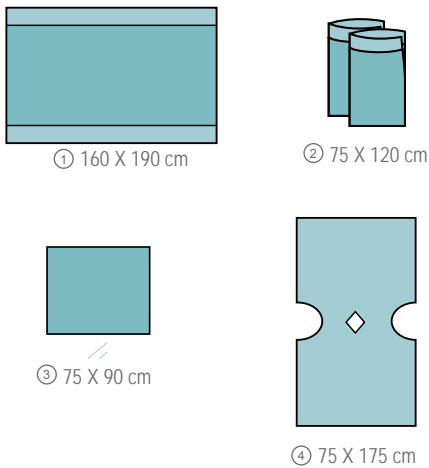

### Cystoscopy Pack

REF1021

No.	Product Name	Size	Quantity
1	Back Table Cover	160×190cm	1
2	Legging	75×120 cm	2
3	Utility Drape	75×90cm	1
4	Cystoscopy Drape	75×175cm	1

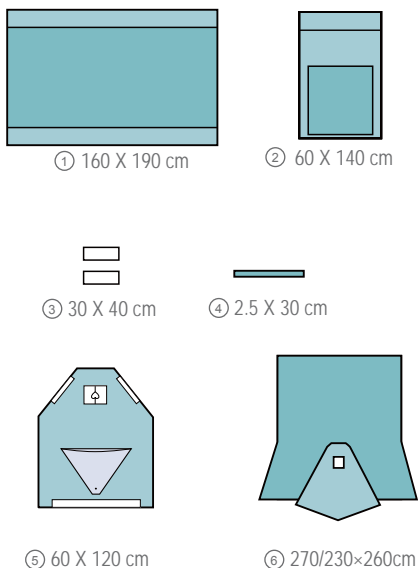

### Gynaecology Pack

REF 1022

No.	Product Name	Size	Quantity
1	Back Table Cover	160×190cm	1
2	Mayo Stand Cover	60×140cm	1
3	Towel	30×40cm	2
4	Tube Holder	2.5×30cm	1
5	Gynaecology Drape with Fluid Collection Pouch	60×120cm	1
6	Gynaecology Drape	270/230×260cm	1

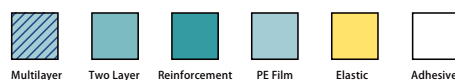

# Surgical Drapes and Packs

## Cardiovascular Packs

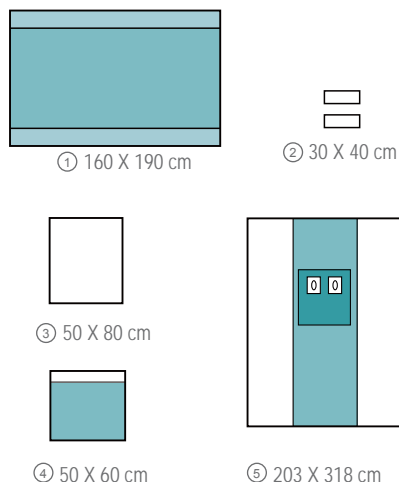

### Angiography Pack I

REF 1023

No.	Product Name	Size	Quantity
1	Back Table Cover	160×190cm	1
2	Towel	30×40cm	2
3	Absorbent Sheet	50×80 cm	1
4	Adhesive Drape	50×60 cm	1
5	Angiography Drape I	203×318 cm	1

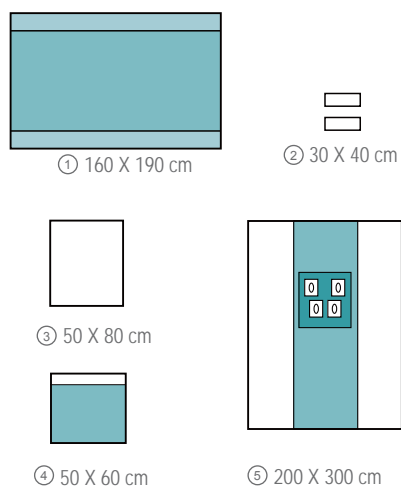

### Angiography Pack II

REF 1024

No.	Product Name	Size	Quantity
1	Back Table Cover	160×190cm	1
2	Towel	30×40cm	2
3	Absorbent Sheet	50×80 cm	1
4	Adhesive Drape	50×60 cm	1
5	Angiography Drape II	200×300 cm	1

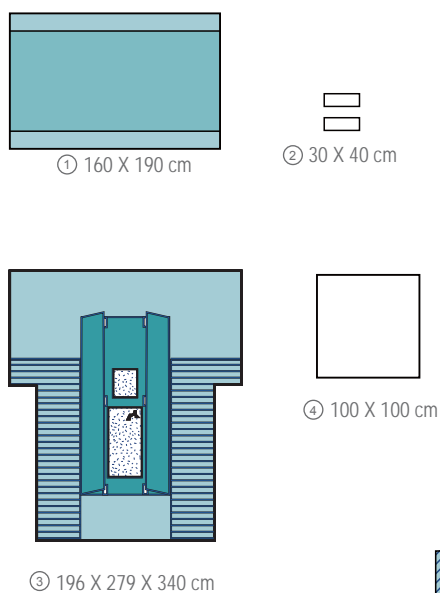

### Cardiovascular Pack

REF 1025

No.	Product Name	Size	Quantity
1	Back Table Cover	160×190cm	1
2	Towel	30×40cm	2
3	Cardiovascular Pack	196×279×340 cm	1
4	SMS Wrap	100×100 cm	1

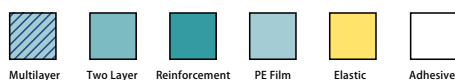



# Surgical Drapes and Packs

## Neurosurgery Packs

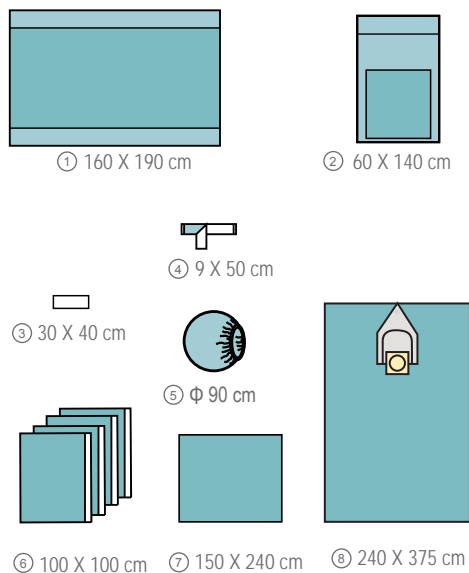

### Craniotomy Pack

REF 1026

No.	Product Name	Size	Quantity
1	Back Table Cover	160×190cm	1
2	Mayo Stand Cover	60×140cm	1
3	Towel	30×40cm	1
4	Op-Tape	9×50cm	1
5	Banded Bag	$\Phi$ 90 cm	1
6	Adhesive Drape	100×100cm	4
7	Utility Drape	150×240 cm	1
8	Craniotomy Drape with Pouch	240×375 cm	1

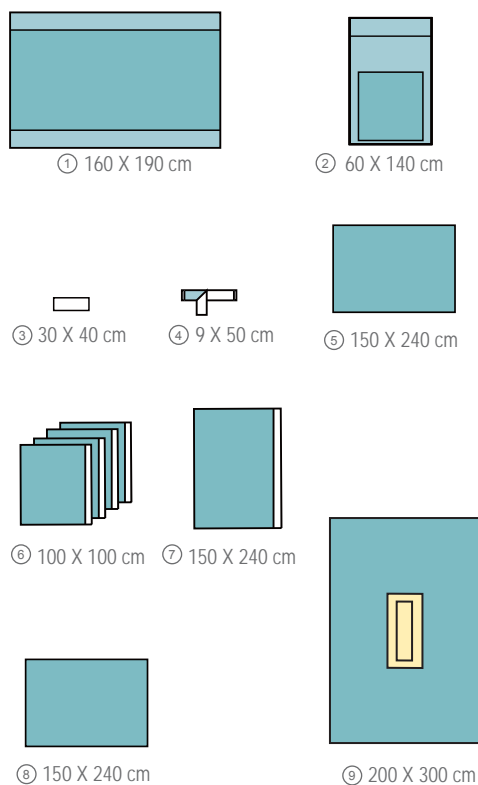

### Spinal Pack

REF1027

No.	Product Name	Size	Quantity
1	Back Table Cover	160×190cm	1
2	Mayo Stand Cover	60×140cm	1
3	Towel	30×40cm	1
4	Op-Tape	9×50cm	1
5	Utility Drape	150×240 cm	1
6	Adhesive Drape	100×100cm	4
7	Adhesive Drape	150×240cm	1
8	Plain Drape	150×240cm	1
9	Shunt Drape	200×300cm	1

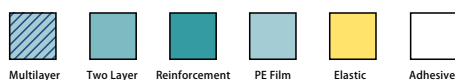

# Surgical Drapes and Packs

## Orthopedics Packs

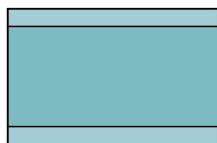

① 160 X 190 cm

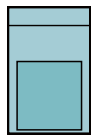

② 60 X 140 cm



③ 30 X 40 cm



④ 9 X 50 cm

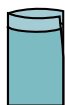

⑤ 74 X 122 cm



⑥ 150 X 240 cm

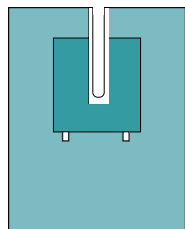

⑦ 230 X 260 cm

### General Orthopedic Pack

REF 1028

No.	Product Name	Size	Quantity
1	Back Table Cover	160×190cm	1
2	Mayo Stand Cover	60×140cm	1
3	Towel	30×40cm	4
4	Op-Tape	9×50cm	1
5	Legging	74×122cm	1
6	Adhesive Drape	150×240cm	1
7	Adhesive Split U Drape	230×260cm	1

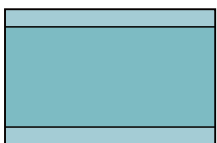

① 160 X 190 cm

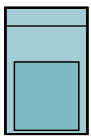

② 60 X 140 cm

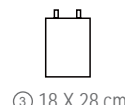

③ 18 X 28 cm

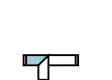

④ 9 X 50 cm

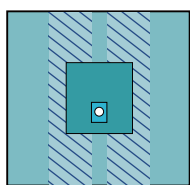

⑤ 230 X 300 cm

### Hand & Foot Pack

REF1029

No.	Product Name	Size	Quantity
1	Back Table Cover	160×190cm	1
2	Mayo Stand Cover	60×140cm	1
3	Suture Bag	18×28cm	1
4	Op-Tape	9×50cm	1
5	Hand & Foot Drape	230×300cm	1



① 160 X 190 cm

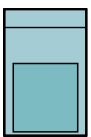

② 60 X 140 cm

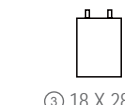

③ 18 X 28 cm



④ 9 X 50 cm

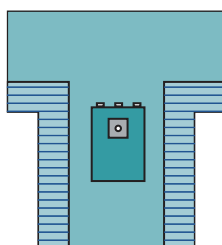

⑤ 229 X 307 X 325 cm

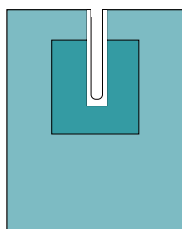

⑥ 137 X 197 cm

### Extremity Pack

REF1030

No.	Product Name	Size	Quantity
1	Back Table Cover	160×190cm	1
2	Mayo Stand Cover	60×140cm	1
3	Suture Bag	18×28cm	1
4	Op-Tape	9×50cm	1
5	Extremity Drape	229×307x325cm	1
6	U-Drape	137×197cm	1

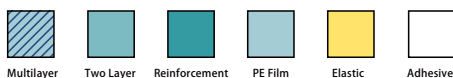

# Surgical Drapes and Packs

## Arthroscopy Packs

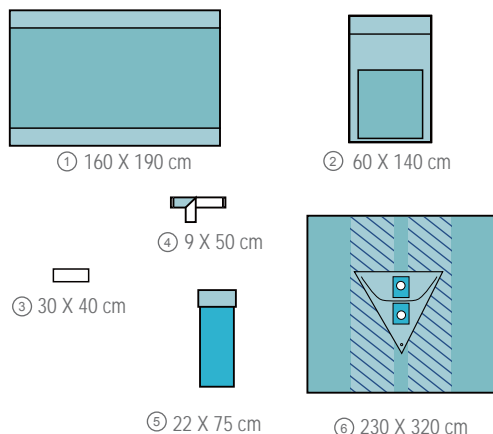

### Arthroscopy Pack I

REF1031

No.	Product Name	Size	Quantity
1	Back Table Cover	160×190cm	1
2	Mayo Stand Cover	60×140cm	1
3	Towel	30×40cm	1
4	Op-Tape	9×50cm	1
5	Stockinette	22×75cm	1
6	Arthroscopy Drape	230×320cm	1

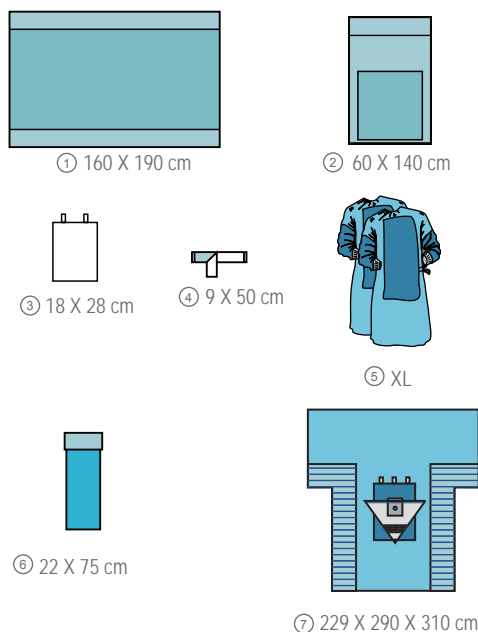

### Arthroscopy Pack II

REF1032

No.	Product Name	Size	Quantity
1	Back Table Cover	160×190cm	1
2	Mayo Stand Cover	60×140cm	1
3	Suture Bag	18×28cm	1
4	Op-Tape	9×50cm	1
5	Reinforced Gown	XL	2
6	Stockinette	22×75cm	1
7	Arthroscopy Drape	229×290×310cm	1

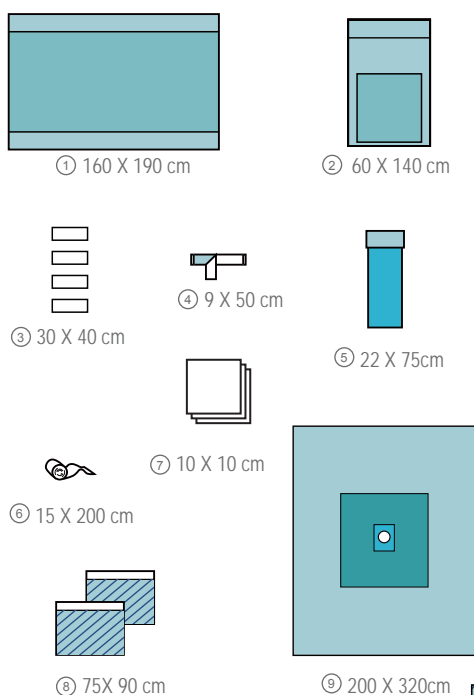

### Shoulder Pack

REF1033

No.	Product Name	Size	Quantity
1	Back Table Cover	160×190cm	1
2	Mayo Stand Cover	60×140cm	1
3	Towel	30×40cm	4
4	Op-Tape	9×50cm	1
5	Stockinette	22×75cm	1
6	Elastic Bandage	15×200cm	1
7	Gauze	10×10cm	10
8	Adhesive Drape	75×90cm	2
9	Shoulder Drape	200×320cm	1

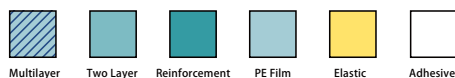

# Hip Packs

## Hip Pack I

REF 1034

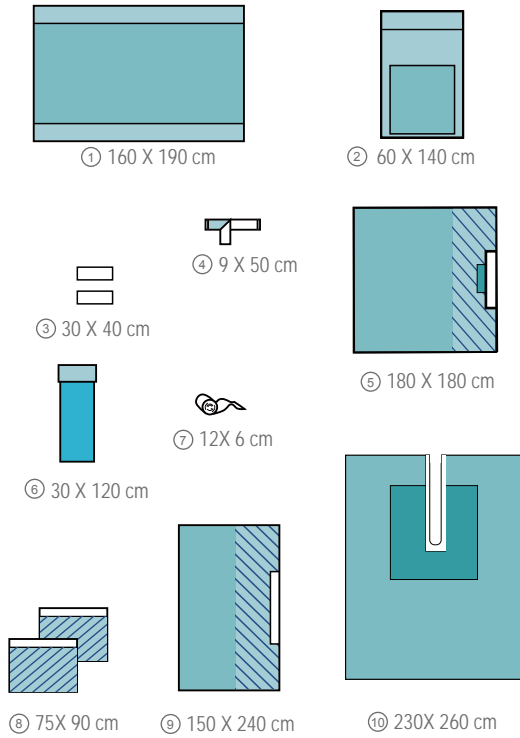

No.	Product Name	Size	Quantity
1	Back Table Cover	160×190cm	1
2	Mayo Stand Cover	60×140cm	1
3	Towel	30×40cm	2
4	Op-Tape	9×50cm	1
5	Adhesive Drape	180×180cm	1
6	Elastic Stockinette	30×120cm	1
7	Elastic Bandage	12×6cm	1
8	Adhesive Drape	75×90cm	2
9	Adhesive Drape	150×240cm	1
10	Adhesive Split U Drape	230×260cm	1

## Hip Pack II

REF 1035

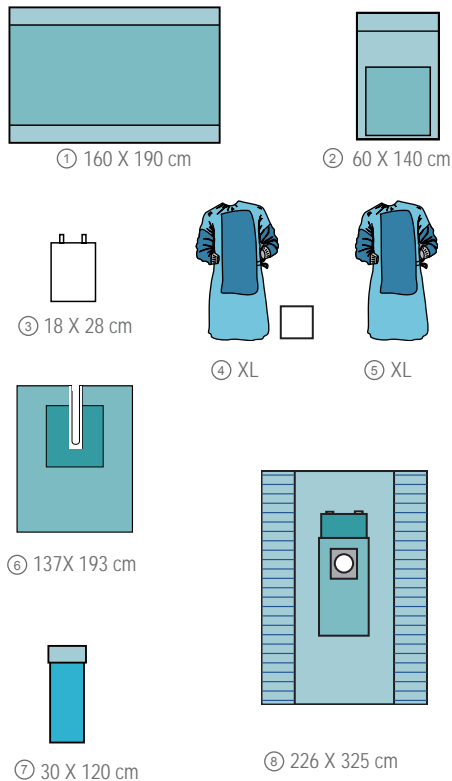

No.	Product Name	Size	Quantity
1	Back Table Cover	160×190cm	1
2	Mayo Stand Cover	60×140cm	1
3	Suture Bag	18×28cm	1
4	Reinforced Gown	XL	1
5	Reinforced Gown with Towel & Wrap	XL	1
6	Adhesive Split U Drape	137×193cm	1
7	Elastic Stockinette	30×120cm	1
8	Hip Drape	226×325cm	1

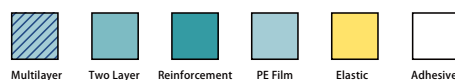

# Surgical Drapes and Packs

## Ophthalmology Packs

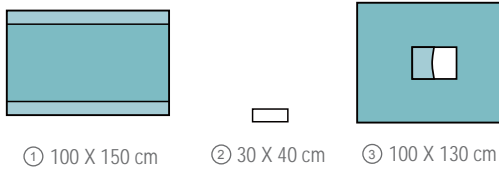

### Ophthalmic Pack I

REF1036

No.	Product Name	Size	Quantity
1	Back Table Cover	100×150cm	1
2	Towel	30×40cm	1
3	Ophthalmic Drape with One Pouch I	100×130cm	1

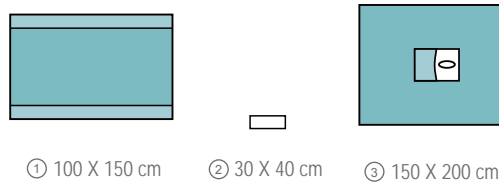

### Ophthalmic Pack II

REF1037

No.	Product Name	Size	Quantity
1	Back Table Cover	100×150cm	1
2	Towel	30×40cm	1
3	Ophthalmic Drape with One Pouch II	150×200cm	1

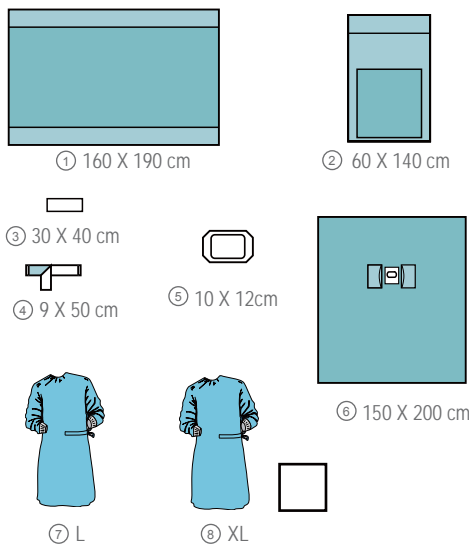

### Ophthalmic Pack III

REF1038

No.	Product Name	Size	Quantity
1	Back Table Cover	160×190cm	1
2	Mayo Stand Cover	60×140cm	1
3	Towel	30×40cm	1
4	Op-Tape	9×50cm	1
5	Incision Film	10×12cm	1
6	Ophthalmic Drape with Two Pouches III	150×200cm	1
7	Standard Gown	L	1
8	Standard Gown with Towel & Wrap	XL	1

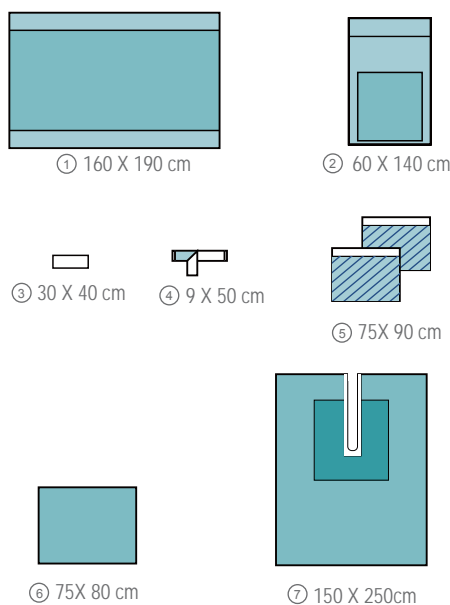

### E.N.T Pack

REF1039

No.	Product Name	Size	Quantity
1	Back Table Cover	160×190cm	1
2	Mayo Stand Cover	60×140cm	1
3	Towel	30×40cm	1
4	Op-Tape	9×50cm	1
5	Adhesive Drape	75×90cm	2
6	Utility Drape	75×80cm	1
7	Adhesive Split Drape	150×250cm	1

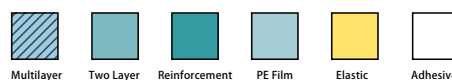

# Surgical Drapes and Packs

## General Drapes

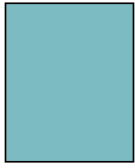

75x90cm

Utility Drape

Code: 10391

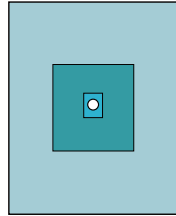

60x140 cm

Fenestration Drape

Code: 10392

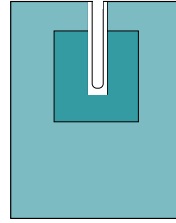

80x145cm

Split Drape

Code: 10393

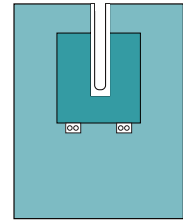

80x145cm

Split Drape with Hook-loop Line Holders

Code: 10394

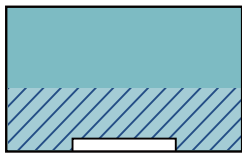

150X240cm

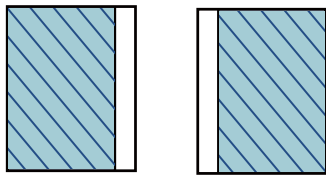

75x90cm

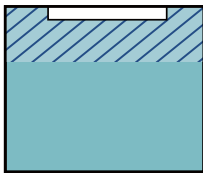

180x180cm

Universal Drape

Code: 10395

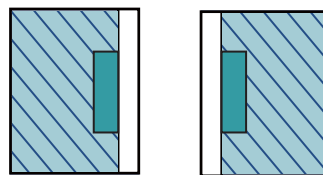
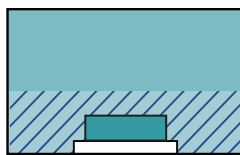

Universal Drape with Reinforced

Code: 10396

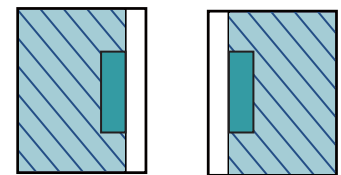
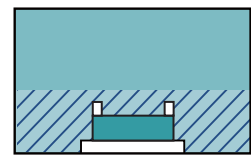

Universal Drape with Hook-loop Line Holders

Code: 10397

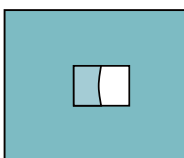

100x150cm

Ophthalmic Drape I

Code: 10398

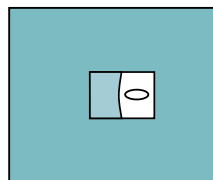

150x200cm

Ophthalmic Drape II

Code: 10399

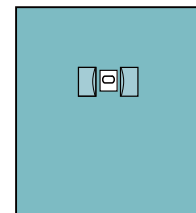

150x200cm

Ophthalmic Drape III

Code: 10400

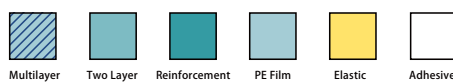

# Surgical Drapes and Packs

## Special Drapes

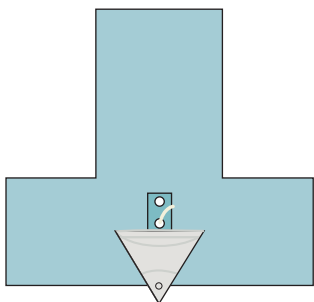

238 X 175 X170 cm

**T.U.R Drape**

Code: 10401

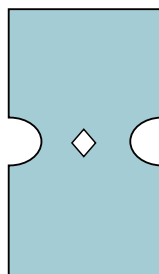

75 X 175 cm

**Cystoscopy Drape I**

Code: 10402

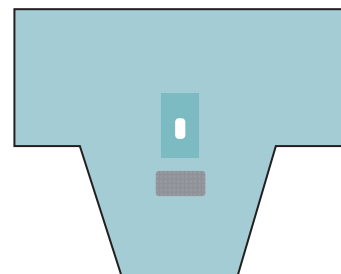

254X 76 X 221 cm

**Cystoscopy Drape II**

Code: 10403

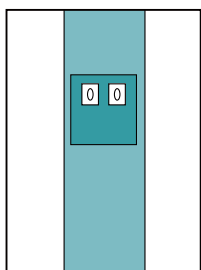

203 X 318 cm

**Angiography drape I**

Code: 10404

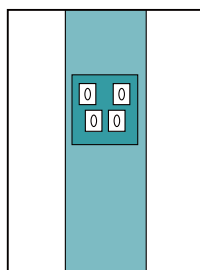

200 X 300 cm

**Angiography drape II**

Code: 10405

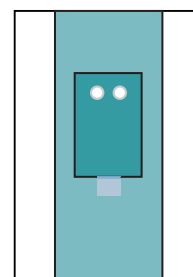

195 X 280 cm

**Angiography drape III**

Code: 10406

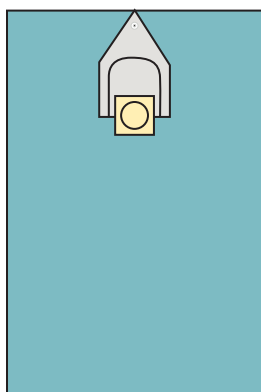

240 X 375 cm

**Craniotomy Drape**

Code: 10407

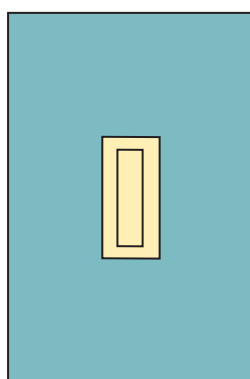

200 X 300 cm

**Spinal Drape**

Code: 10408

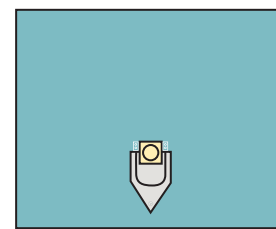

254x240cm

**Neurological Drape**

Code: 10409

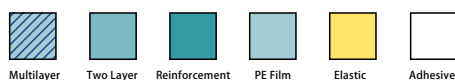

# Surgical Drapes and Packs

## Special Drapes

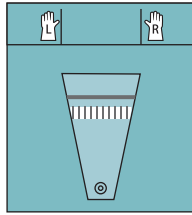

102 X 112 cm

**Obstetrical Drape**

Code: 10410

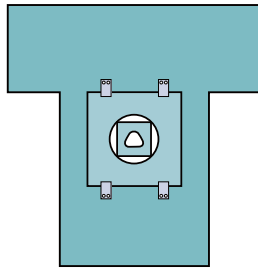

186 X 250 X 330 cm

**Cesarean Drape I**

Code: 10411

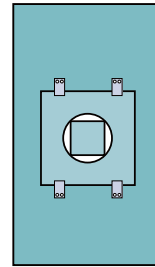

330 X 230 cm

**Cesarean Drape II**

Code: 10412

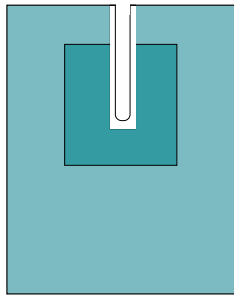

230 X 260 cm

**Orthopedic U Drape**

Code: 10413

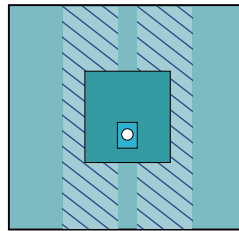

230 X 300 cm

**Hand & Foot Drape**

Code: 10414

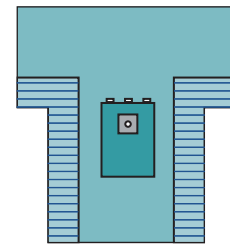

229 X 307 X 325 cm

**Extremity Drape**

Code: 10415

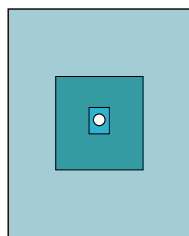

22 X 75cm

**Shoulder Drape**

Code: 10416

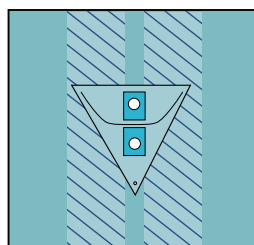

230 X 320 cm

**Arthroscopy Drape I**

Code: 10417

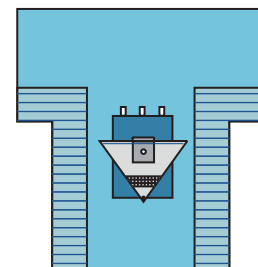

229 X 290 X 310 cm

**Arthroscopy Drape II**

Code: 10418

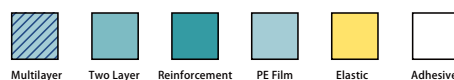



# Surgical Drapes and Packs

## Other Components

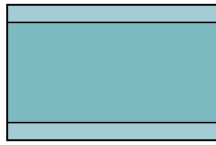

160×190 cm

**Back Table Cover**

Code: 10419

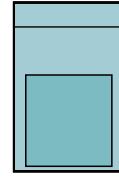

60×140 cm

**Mayo Stand Cover**

Code: 10420

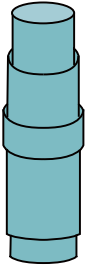

8 X 120 cm

**Tube Cover**

Code: 10421

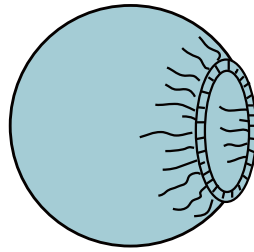

Φ 90 cm

**Banded Bag**

Code: 10422



75 X 120 cm

**Baby Blanket**

Code: 10423



30 X 40 cm

**Hand Towel**

Code: 10424

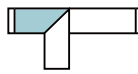

9 X 50 cm

**Op-Tape**

Code: 10425



74 X 122 cm

**Legging**

Code: 10426

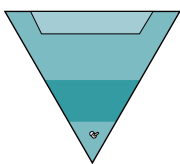

62 X 50 cm

**Fluid Collection Pouch**

Code: 10427



32 X 120 cm

**Elastic Stockinette**

Code: 10428

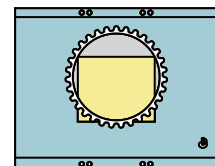

100 X 80 cm

**Incise Pouch**

Code: 10429

